

ASSEMBLY INSTRUCTIONS /  
INSTRUCTIONS D'ASSEMBLAGE

---

ITEM NO/NO ARTICLE: SLOAN2PK/253397-X2

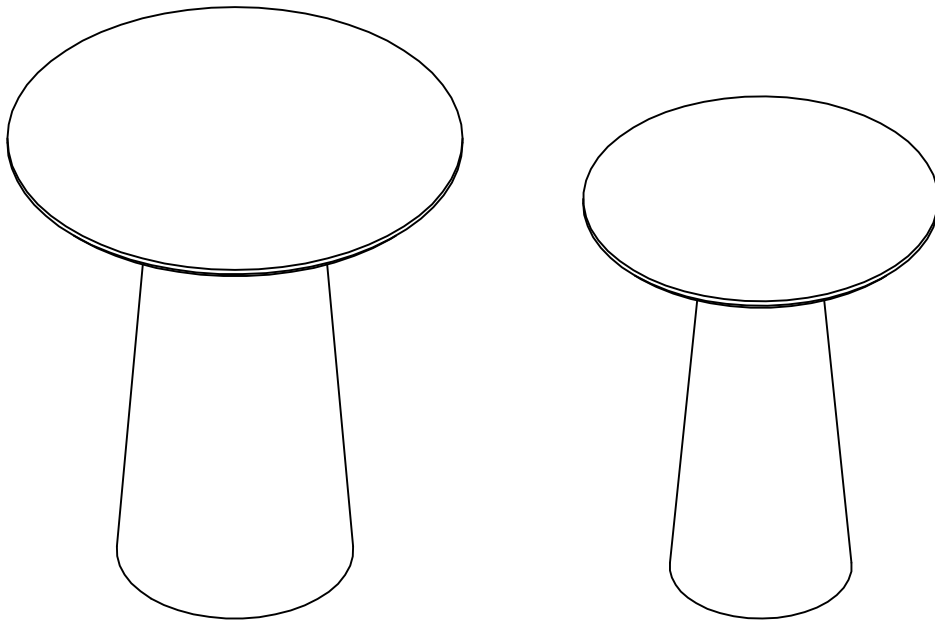

PARTS IDENTIFICATIONS /  
IDENTIFICATION DES PIECES

ITEM NO/NO ARTICLE: SLOAN2PK/253397-X2

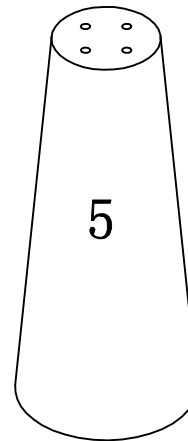
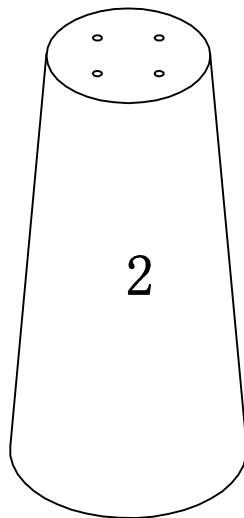
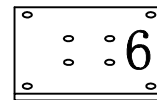
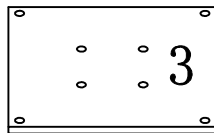
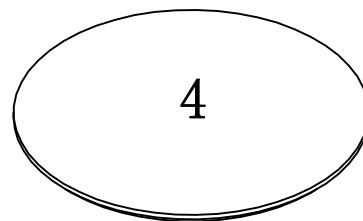
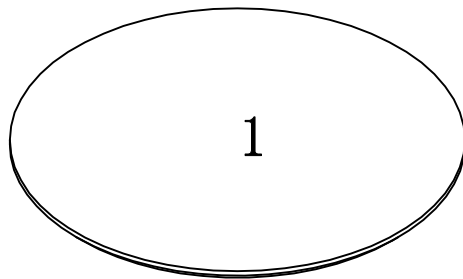

- |     |         |
|-----|---------|
| (1) | 1pc/pce |
| (2) | 1pc/pce |
| (3) | 1pc/pce |
| (4) | 1pc/pce |
| (5) | 1pc/pce |
| (6) | 1pc/pce |

HARDWARE IDENTIFICATIONS/  
IDENTIFICATION DU KIT D'ASSEMBLAGE

ITEM NO/NO ARTICLE: SLOAN2PK/253397-X2

A

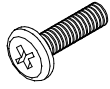

$\Phi 6x20$

16pcs/pces

STEP 1 / ETAPE 1

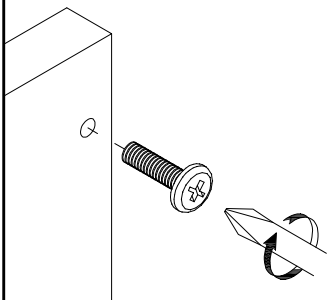
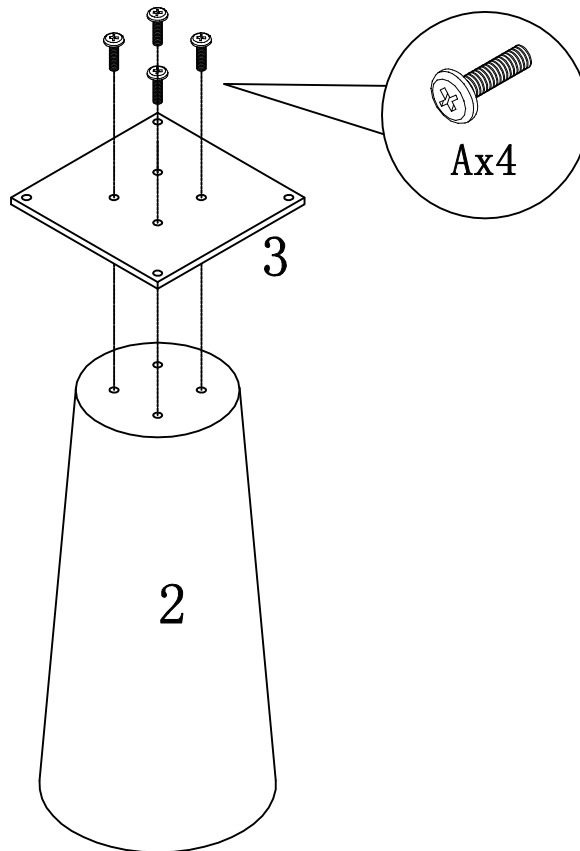

TOOLS REQUIRED (NOT INCLUDED)  
OUTILS REQUIS (NON COMPRIS)

# ITEM NO/NO ARTICLE: SLOAN2PK/253397-X2

## STEP 2 / ETAPE 2

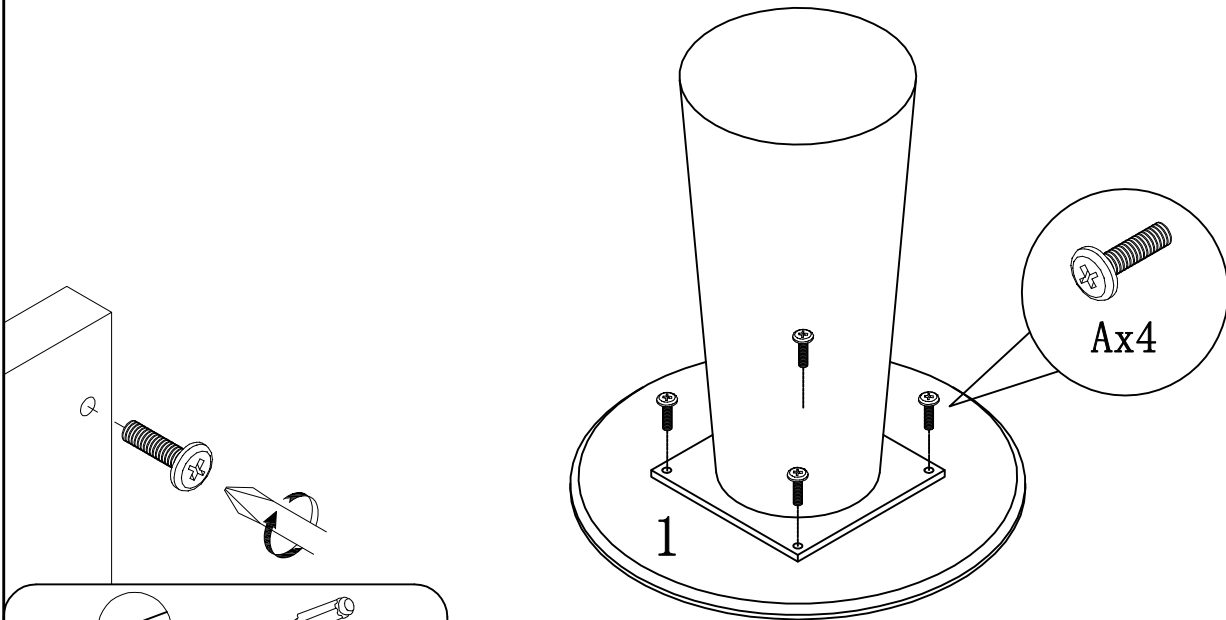

TOOLS REQUIRED (NOT INCLUDED)  
OUTILS REQUIS (NON COMPRIS)

## STEP 3 / ETAPE 3

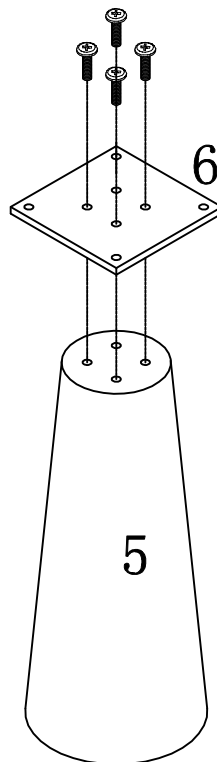

TOOLS REQUIRED (NOT INCLUDED)  
OUTILS REQUIS (NON COMPRIS)

# ITEM NO/NO ARTICLE: SLOAN2PK/253397-X2

## STEP 4 / ETAPE 4

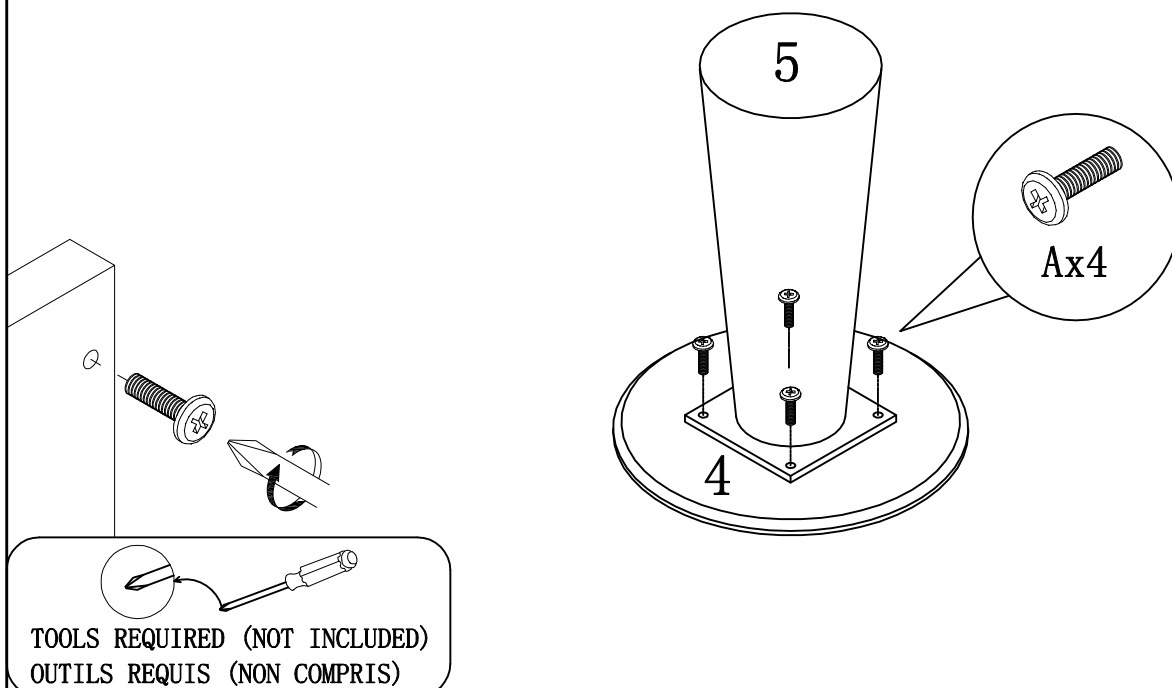

## STEP 5 / ETAPE 5

