

ASSEMBLY INSTRUCTIONS /  
INSTRUCTIONS D'ASSEMBLAGE

---

ITEM NO/NO ARTICLE: CEDRICST/253398

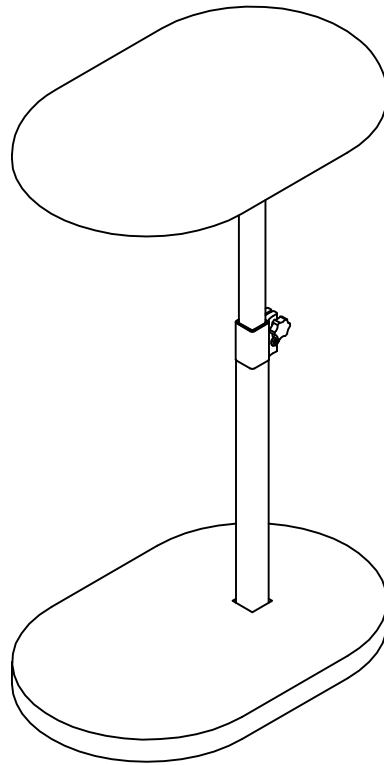

# PARTS IDENTIFICATIONS / IDENTIFICATION DES PIECES

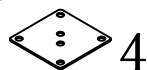
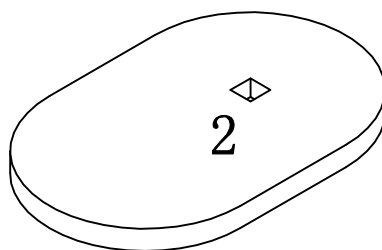
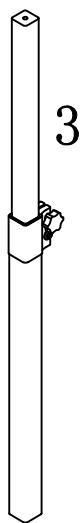
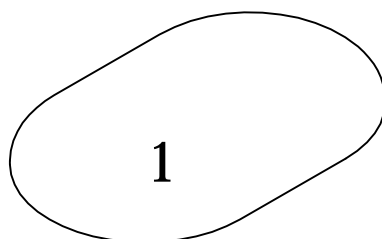

ITEM NO/NO ARTICLE: CEDRICST/253398



- |     |         |
|-----|---------|
| (1) | 1pc/pce |
| (2) | 1pc/pce |
| (3) | 1pc/pce |
| (4) | 1pc/pce |
| (5) | 1pc/pce |

HARDWARE IDENTIFICATIONS/  
IDENTIFICATION DU KIT D'ASSEMBLAGE

ITEM NO/NO ARTICLE: CEDRICST/253398

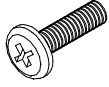
A		$\Phi 25$	4pcs/pces
B		$\Phi 6x8$	8pcs/pces
C		$\Phi 6x15$	3pcs/pces

# ITEM NO/NO ARTICLE: CEDRICST/253398

## STEP 1 / ETAPE 1

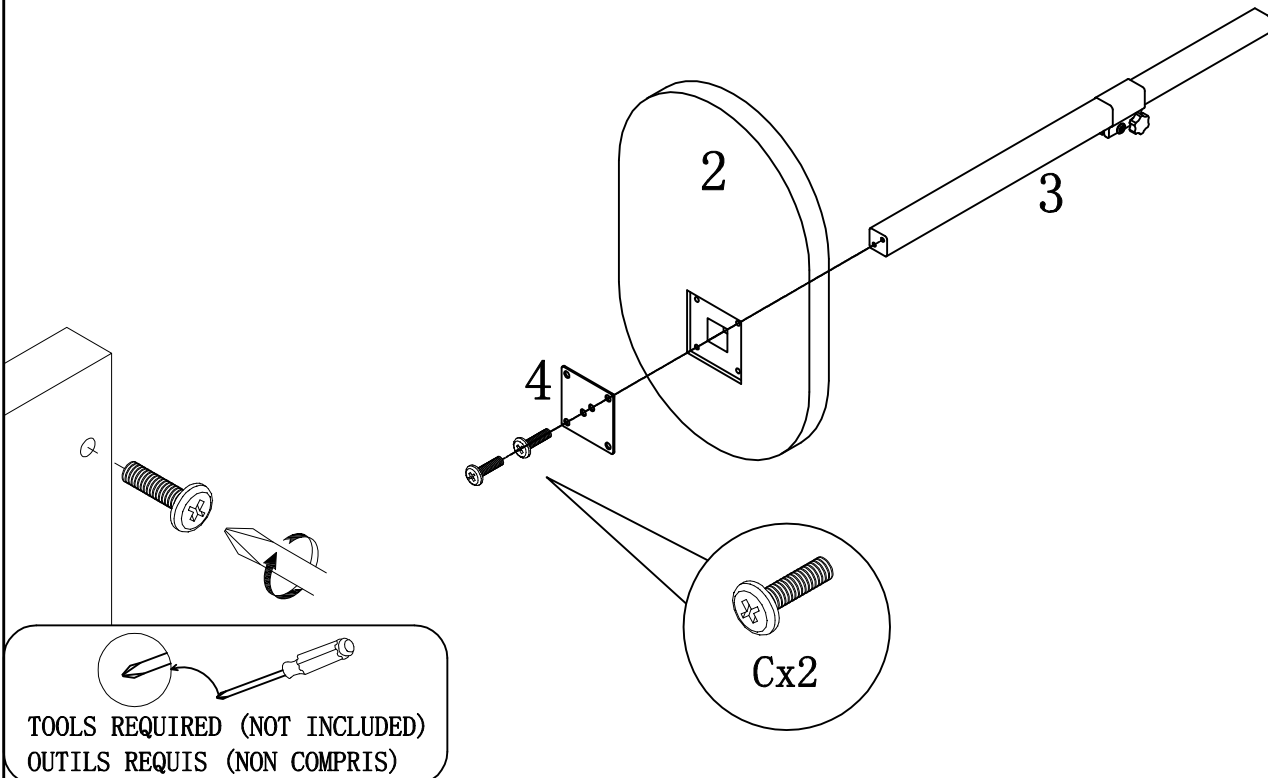

## STEP 2 / ETAPE 2

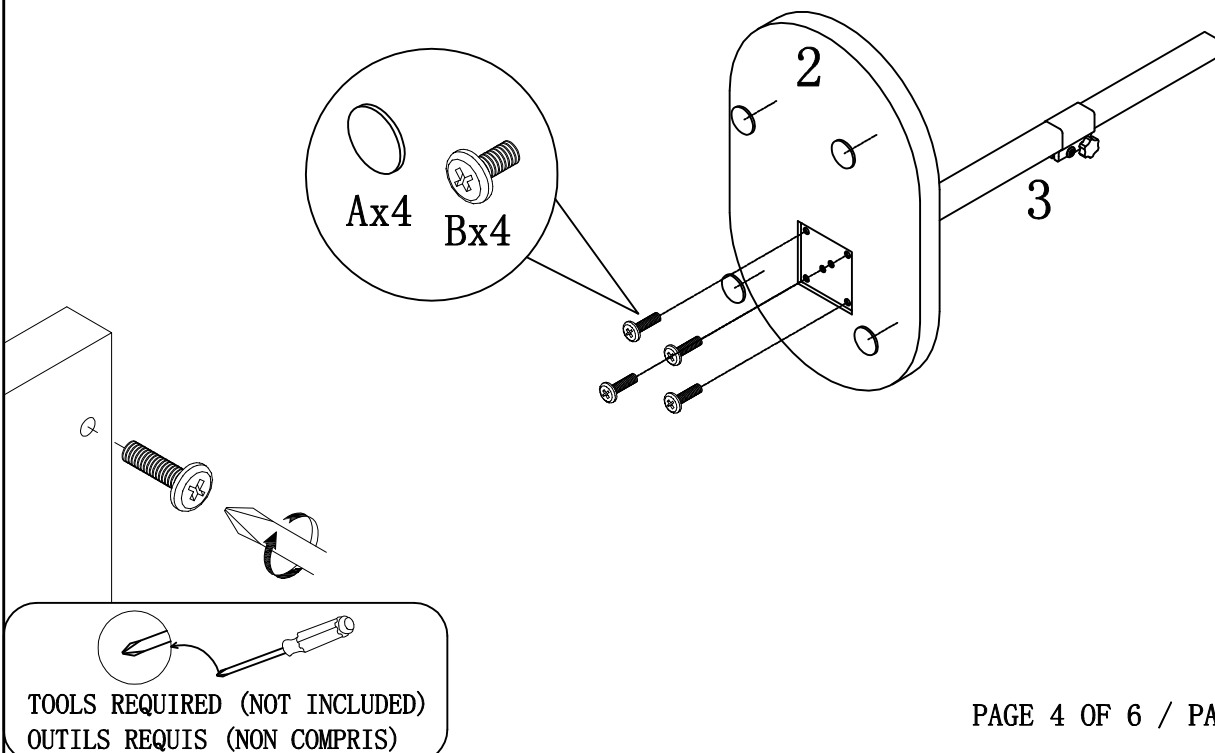

# ITEM NO/NO ARTICLE: CEDRICST/253398

## STEP 3 / ETAPE 3

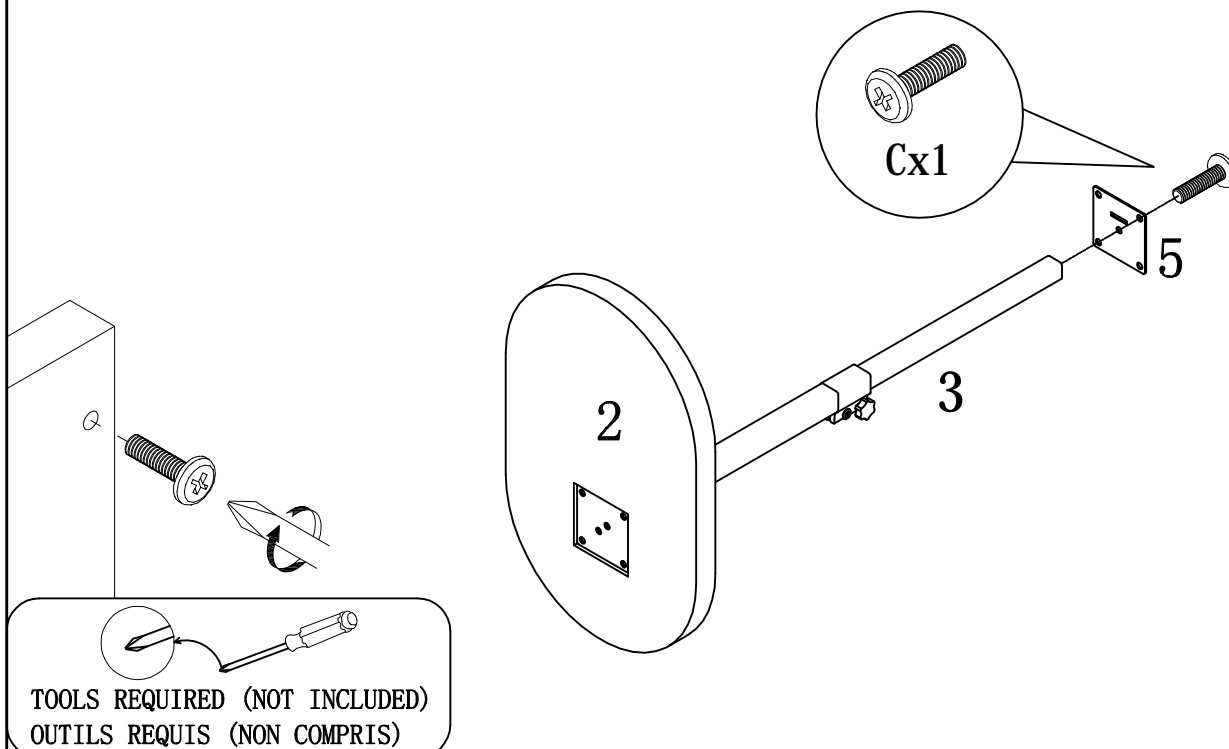

## STEP 4 / ETAPE 4

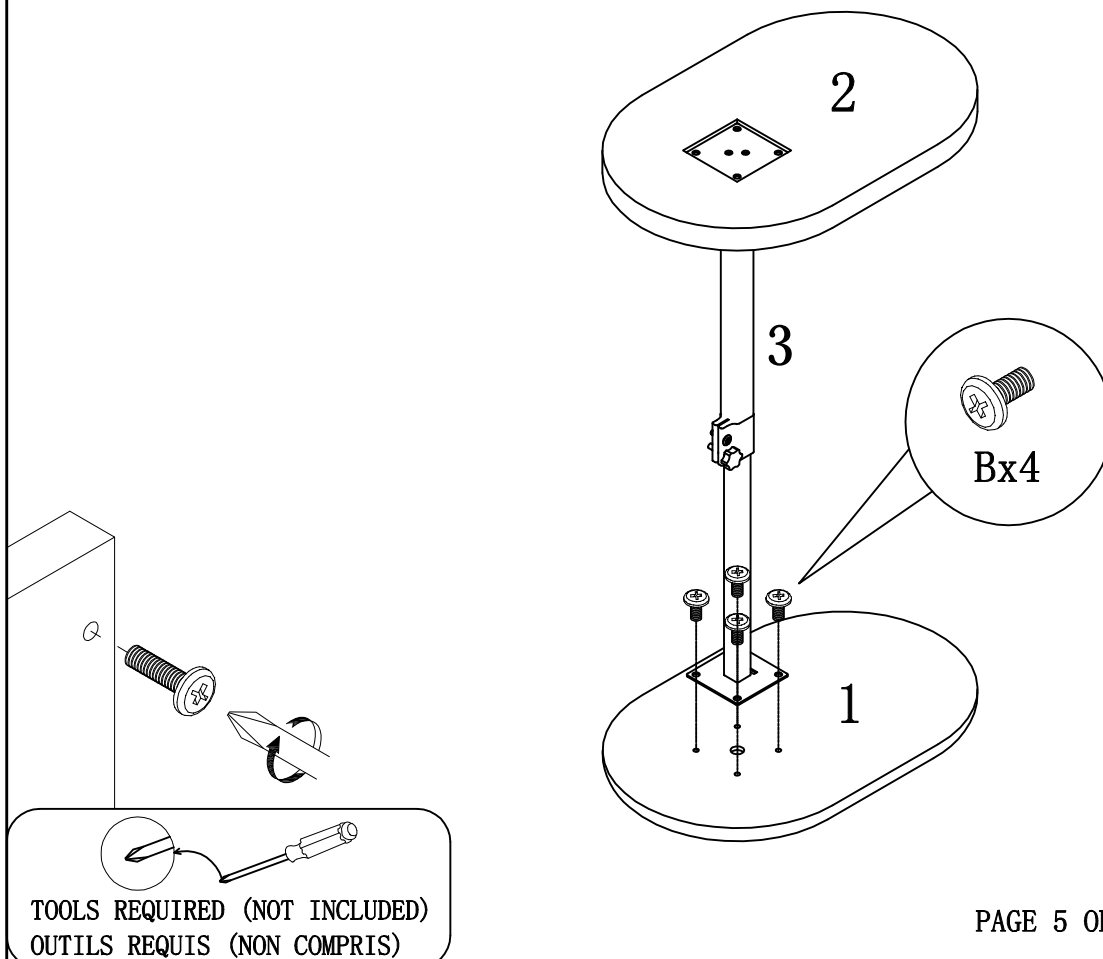

# ITEM NO/NO ARTICLE: CEDRICST/253398

---

STEP 5 / ETAPE 5

